

HEAT SPREADER PROCESS OVERVIEW

ELECTRONICS AND CHEMICALS

Honeywell

A photograph of two scientists in a cleanroom environment. They are wearing white lab coats, blue hairnets, and light blue surgical masks. The scientist on the right is also wearing safety glasses and white gloves, and is holding a tablet computer. They are both looking at the tablet. The background shows industrial equipment and a clean, bright setting.

HONEYWELL OVERVIEW

NASDAQ: HON | ~750 sites | ~99,000* employees | Charlotte, NC headquarters | Fortune 500 | 2022 Revenue: ~\$35 B

AEROSPACE



Our products are used on virtually every commercial and defense aircraft platform worldwide and include aircraft propulsion, cockpit systems, satellite communications, and auxiliary power systems.

HONEYWELL BUILDING TECHNOLOGIES



Commercial building owners and operators use our hardware, software and analytics to help create safe, efficient and productive facilities. Our solutions and services are used in more than 10 million buildings worldwide.

PERFORMANCE MATERIALS & TECHNOLOGIES



We provide performance chemicals and materials, process technologies, and automation controls. By supporting the global transition towards renewable energy and low-carbon economy, we're accelerating a more sustainable future to help change the world.

SAFETY & PRODUCTIVITY SOLUTIONS



We develop and deploy an innovative range of solutions, software, and services that help keep people healthy, workers and workplaces safer and more productive, and supply chains and assets more efficient, accurate, and reliable.

HONEYWELL CONNECTED ENTERPRISE

Across our segments, we empower those who make, move and operate the world's critical resources to grow responsibly. HCE develops software that securely unites OT and IT data to make better decisions and improve operational performance. Our flagship suite of applications, Honeywell Forge unites real-time data across assets, people and processes to drive intelligent operations growth, productivity and risk mitigation.

Shaping the Future Across Industries

ADVANCED MATERIALS



Honeywell Advanced Materials is an industry leading solutions provider, playing a crucial role in advancing industries worldwide through diverse applications, revolutionary inventions, and pioneering technologies focused on high growth mega-trends.

Our science and technology experts create solutions that enable our customers to overcome their challenges today and into the future.



OUR SOLUTIONS / SERVICES



**AIR
CONDITIONING &
REFRIGERATION**



**BUILDING AND
APPLIANCE
INSULATION**



**PERSONAL CARE
AND PHARMA**



**SPECIALTY
ADDITIVES**



**THERMAL
MANAGEMENT
MATERIALS**



**HIGH PURITY
CHEMICALS**

AM ADDRESSING KEY MACRO TRENDS



400+
Technologists
and Engineers



5,100
Active patents
and applications



3,000+
Employees globally

Impact of **Solstice** technologies globally equals to removing emissions of **62 million cars** from a road for one year.

*Figures represent 2022 STRAP



SUSTAINABILITY

Driven by need for sustainable solutions for climate change

Solutions:

Solstice refrigerants, foam blowing agents, propellants



ENERGY TRANSFORMATION

Driven by need to convert to clean, renewable energy sources

Solutions:

Nuclear, Battery Chemicals



DIGITALIZATION

Driven by an acceleration in consumption of data in connected solution

Solutions:

Targets, Heat Spreaders



LIFE SCIENCES

Driven by aging population and a transition to biologics

Solutions:

Aclar, Medical Fibers, Research Chemicals

A high-performing, material-science-driven business

AM A GLOBAL MATERIALS AND TECHNOLOGY BUSINESS

FLUORINE PRODUCTS

INDUSTRY INNOVATOR

- Offers solutions based on Honeywell's Solstice HFO technology, enabling customers to lower their carbon footprint without sacrificing end-product performance.
- **Products:** Refrigerants, blowing agents, aerosol propellants and cleaning solvents
- **Key End Markets:**
 - Air Conditioning & Refrigeration
 - Building and Appliance Insulation
 - Personal Care and Pharma

LIFE SCIENCES, PROTECTIVE, AND INDUSTRIAL SOLUTIONS

TECHNOLOGY LEADER

- **Spectra light-weight-high-strength fiber** used in military, law enforcement, medical and industrial applications
- **Aclar barrier protection** material offered as: consumer-friendly film for blister packs; bottles and vials for use in the animal and healthcare space
- Leading **Additives** manufacturer of Polyethylene waxes used as rheology modifiers, lubricants or dispersing agents in construction, e.g. pipe extrusion; inks and coatings applications

ELECTRONICS AND CHEMICALS

QUALITY & APPLICATIONS LEADER

- **High purity chemicals** for the personal care, auto, pharma, and semiconductor industries
- Sputtering **targets** for chip metallization
- Heat spreaders, TIMs, thermocouples and electrical interconnect materials
- High reliability **phase change materials** for thermal management
- Manufacturer of **high-purity solvents and reagents** for laboratory research and testing applications
- Manufacturer of **taggants and detectors** for high security currency and document authentication

Delivering Strong Innovation And Applications Development For Customers

HEAT SPREADERS | OVERVIEW

Heat Spreader (aka 'lid') used to dissipate heat away from the chip

Designed for moderate to high performance applications (e.g., high-end desktop and server CPUs)

Also used in other applications: memory and power devices (e.g., Inverters)

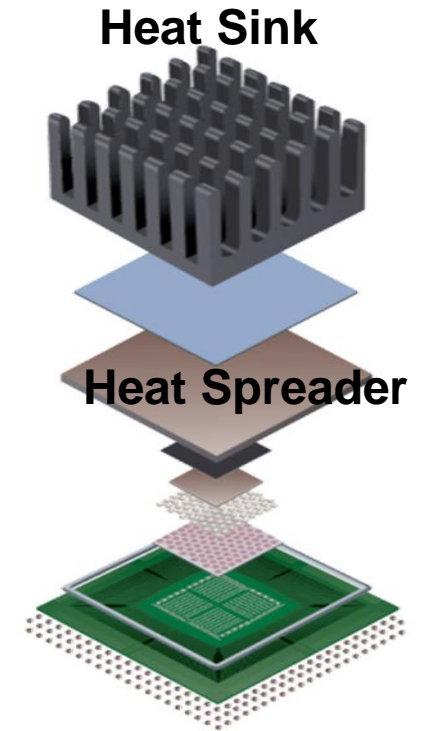
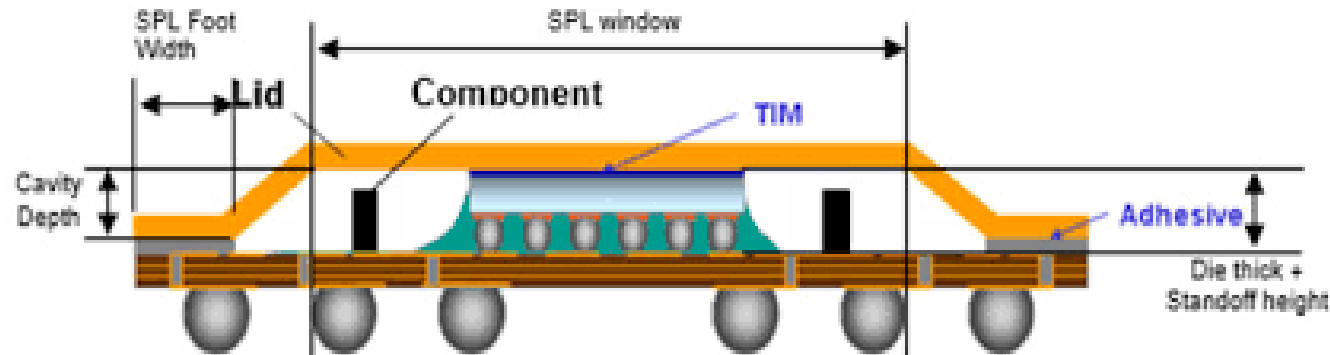

HONEYWELL HEAT SPREADERS | RANGE, RELIABILITY, AND QUALITY

- Full range of stamping technologies
 - From coining, high-speed progressive stamping to multi-stage, high tonnage transfer die stamping to achieve large, complex geometries for Cu Integrated Heat Spreaders
 - Capable of manufacturing other precision stamped products
- Highly reliable plating technologies to achieve consistency in surface finish
 - Continuous Ni plating lines
 - Au spot plating (Mil. Standard)
- Manufacturing plant located in Chonburi, Thailand
 - Good infrastructure and proximity to customers in Southeast Asia & Greater China
 - High-quality talent pool
 - Strong and reliable vendor base
- Robust quality management system backed by Honeywell Operating System (HOS) principles
 - Comprehensive suite of metrology and testing tools
 - ISO 9001 certification

HEAT SPREADERS | CHONBURI SITE OVERVIEW

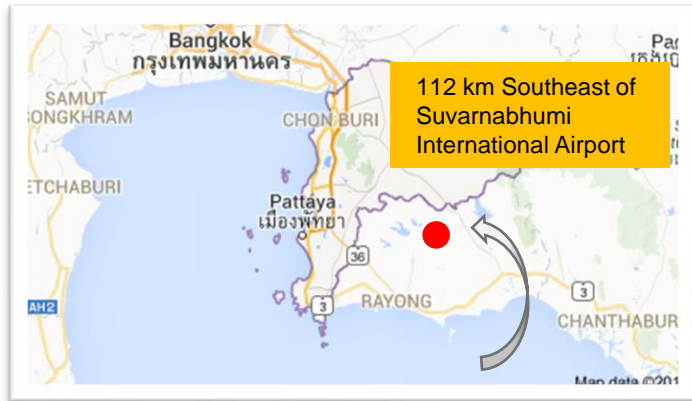

Location

Chonburi Province, Bo-win City
Chonburi Industrial Park (Bo-Win)

Site Facts

- Owned site – 300K sq.ft.
- Built up area – 138.5K SF (Production – 103K sq.ft. Office – 7.5K sq.ft. W/H & Other – 28K sq.ft.)
- Empty area for further expansion – estimated 60K sq.ft.



Proximity to customers in Southeast Asia & Greater China

HEAT SPREADERS | EQUIPMENT AND CAPABILITY

Raw Material

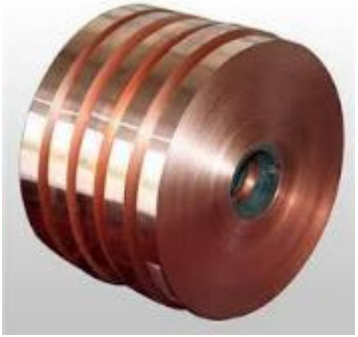

Coil form

- Copper
- Aluminum
- S Steel

Stamping



Transfer Press

- 3x - 300 Ton
- 2x - 600 Ton
- 1x - 800 Ton
- 1x - 1200 Ton

Coining

- 2x - 330 Ton

Stamping

- 1x - 110 Ton

Plating



Nickel

- 2x-Legacy CPL
- 5x-New CPL

Gold spot

- 3x - Automated
- 1x - Semi Auto

Final Inspection



Instrument

- CMM – Contact measure
- ZYGO – Surface scan
- OGP – Non-Contact
- XRF – Ni/Au Thickness
- 3D scan – Surface Scan
- Visual inspection – AOI & Manual type

Well equipped to manufacture & deliver quality products to our customers

HEAT SPREADERS | STAMPING CAPABILITY OVERVIEW



Advanced Stamping Techniques for Complex Geometries

- Significant experience with Cu-based, Al-based & stainless-steel materials
- Capable of stamping large parts. Experience w/ part thicknesses from 0.5mm to 3.5mm and above
- Tight tolerances for critical parameters:
 - Outer & Inner Diameter ($\pm 0.05\text{mm}$); Cavity depth ($\pm 0.05\text{mm}$); Surface profiles ($\pm 0.003\text{mm}$); Top/cavity flatness tolerances

Complex Geometries

- Transfer die & progressive stamping to achieve complex features (multiple cavities, wings, flanges, etc.)
- Hybrid approach (stamping + machining) to achieve very complex geometries

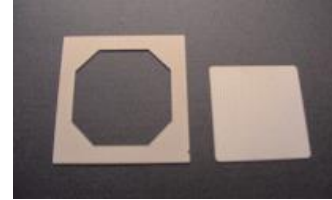
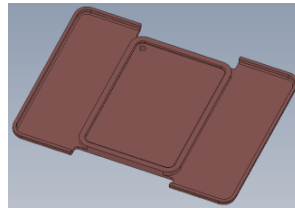

Parts With Varying Complexity

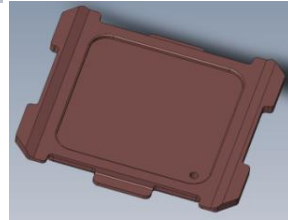

Capable of Complex Designs with Tight Tolerances

HEAT SPREADERS | PLATING CAPABILITY OVERVIEW



Continuous Plating for repeatability and consistency in high volume manufacturing



Plating Processes Surface Finishes

- **Nickel (Ni)** (semi-bright / dull)
- **Gold (Au)** (selective spot plating / 24K / Mil spec.)
- High speed continuous plating lines for repeatability and consistency
- Control over critical parameters:
 - Brightness & Gloss; Roughness – Ra & Ry; Ni & Au thicknesses, etc.

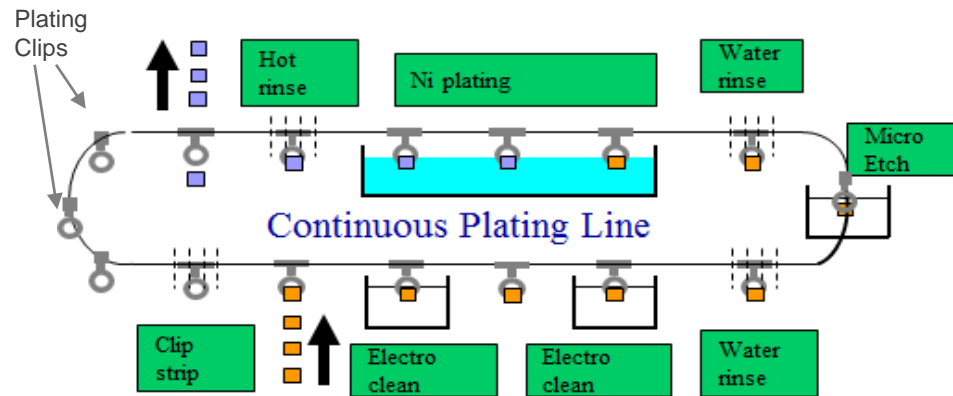

In continuous plating, parts are attached to clips and travel through each process cell in sequence, ensuring consistent surface finish across all parts

Reliability & Consistency in Plating

HEAT SPREADERS | METROLOGY & QUALITY ASSURANCE

Metrology

- Full-scale testing & chemical analysis lab
- Robust suite of metrology
 - Coordinate measurement machine (CMM); XRF (Ni/Au thickness); Non-contact laser profile scanner (OGP); White light interferometer (Zygo); X-rite (brightness); Gloss meter; Tensile strength testing (Instron)



HOS & Quality Management System

- QMS structure defines global responsibilities for standardized approach to quality management
- Aligned to ISO9001 requirements, conversion to ISO9001:2015 in process
- Honeywell Operating System (HOS) ensures a broad application of Lean and Six Sigma tools against a construct of standardized work, rapid problem solving, continuous improvement and knowledge sharing
- Employee skills maintained through enrollment in seminars and continuing education programs



QMS Structure

Best-in-class Quality Assurance

STAMPING AND PLATING PROCESS

HEAT SPREADERS | PROGRESSIVE STAMPING/PLATING PROCESS

Progressive Stamping- Simple Parts



Copper (Cu)
Strip

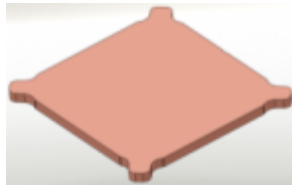

Blanking

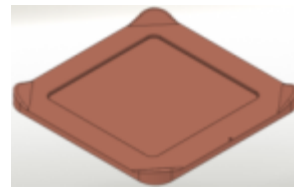

Coining

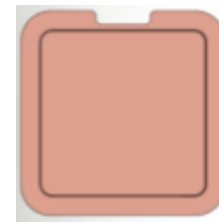

Trimming



Nickel (Ni)
Plating*



Gold (Au) Plating
**

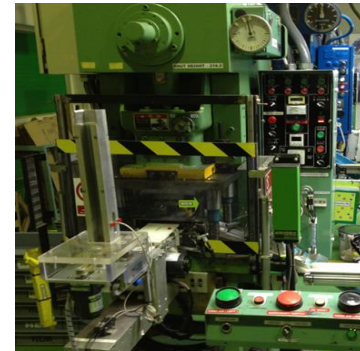

Foundational Technology:

- Individual Press for each step
- Can produce Small Form Factor (SFF) & Medium Form Factor (MFF) Parts
 - 40-50mm sq max
- Low Volume – semi batch processes
- Simplified Part Design

*All Parts Ni plated

**Only some parts are Au plated

HEAT SPREADERS | PROGRESSIVE STAMPING/PLATING CAPABILITY

- Max size: 46.5mm x 50mm
- OD & ID: $\pm 0.05\text{mm}$
- Radii: $> 0.30\text{mm}$
- Seal band Width: $\pm 0.050\text{mm}$
- Thickness: $\pm 0.050\text{mm}$ ($< 3\text{mm}$); $\pm 0.1\text{mm}$ ($> 3\text{mm}$)
- Topside & Cavity Flatness by Part Area:
 - 0.04mm @ $40 \times 40 \text{ mm}^2$
 - 0.07mm @ $50 \times 50 \text{ mm}^2$
- Flange Width: $\pm 0.10\text{mm}$
- Cavity Depth: $\pm 0.05\text{mm}$
- Surface profile: $\pm 0.003\text{mm}$

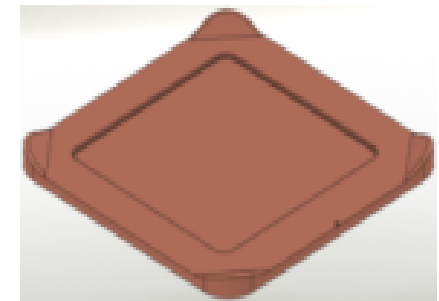
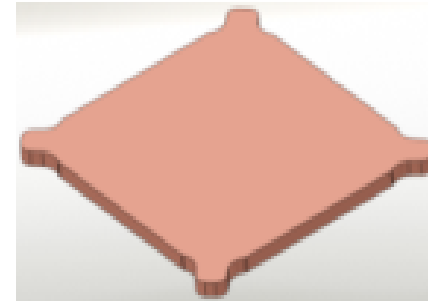

ADVANCED STAMPING/PLATING

HEAT SPREADERS | PROGRESSIVE VS TRANSFER DIE

Progressive Stamping- Simple Parts

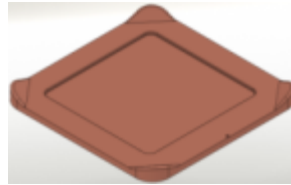
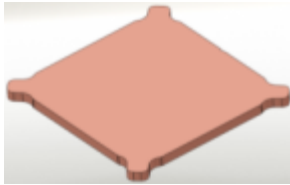

Copper (Cu) Strip

Blanking

Coining

Trimming

Nickel (Ni) Plating*

Gold (Au) Plating**

Transfer Die Stamping – Complex Parts

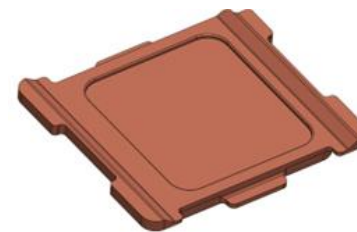

Copper (Cu) Strip

Stamped Part

Ni Plating*

Au Plating**

Transfer Die offers streamlined, modern process

*All Parts Ni plated
**Only some parts are Au plated

HEAT SPREADERS | ADVANCED STAMPING/PLATING PROCESS

Transfer Die Stamping – Complex Parts



Copper Strip

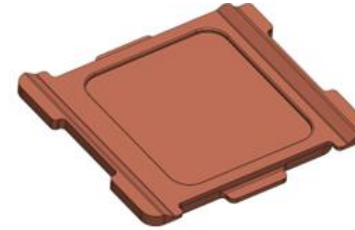

Stamped Part



Nickel Plating*



Gold Plating**

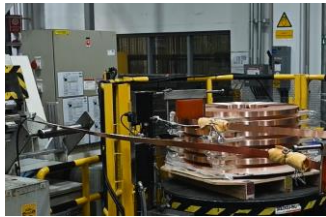

Advanced Lines:

- Cutting-Edge Technology
- High Volume - Continuous Processes (vs. batch/semi-batch)
 - Transfer Die Stamping – Multiple stations within 1 press
 - Can produce SFF-XLFF (130mm sq max)
- Wide range and volume of parts that can be processed
- Complex parts/shapes

*All Parts Ni plated

**Only some parts are Au plated

HEAT SPREADERS | ADVANCED STAMPING LINE

CAPABILITY / TOLERANCES

- Max size: 130mm x 130mm
- OD & ID: $\pm 0.05\text{mm}$
- Radii: $> 0.30\text{mm}$
- Seal band Width: $\pm 0.040\text{mm}$
- Thickness: $\pm 0.050\text{mm}$ ($< 3\text{mm}$); $\pm 0.05\text{mm}$ ($> 3\text{mm}$)
- Topside & Cavity Flatness by Part Area:
 - 0.04mm @ $40 \times 40 \text{ mm}^2$
 - 0.07mm @ $50 \times 50 \text{ mm}^2$
 - 0.12mm @ $60 \times 60 \text{ mm}^2$
 - 0.20mm @ $70 \times 70 \text{ mm}^2$
- Flange Width: $\pm 0.10\text{mm}$
- Cavity Depth: $\pm 0.05\text{mm}$
- Surface profile: $\pm 0.003\text{mm}$
- Pedestal Depth: $\pm 0.050\text{mm}$
- Pedestal X,Y: $\pm 0.050\text{mm}$

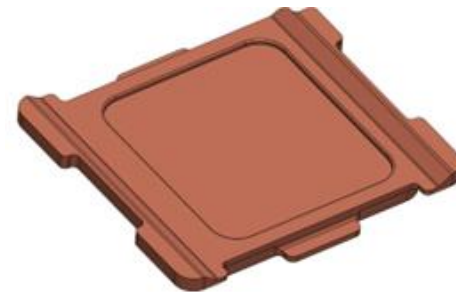

SUMMARY

- **Experts & leaders in the stamping and plating industry**
- **Decades of knowledge and experience**
- **Positioned to maximize and optimize process performance to meet our customers' needs**

We are committed to meeting your needs. How can we help you?

**THANK
YOU**

Honeywell

HEAT SPREADERS | PROGRESSIVE STAMPING/PLATING

Coining Presses



Trimming Press



HEAT SPREADERS | LEGACY NICKLE PLATING

Nickle Plating



Nickle Plating



HEAT SPREADERS | LEGACY GOLD PLATING & INSPECTION

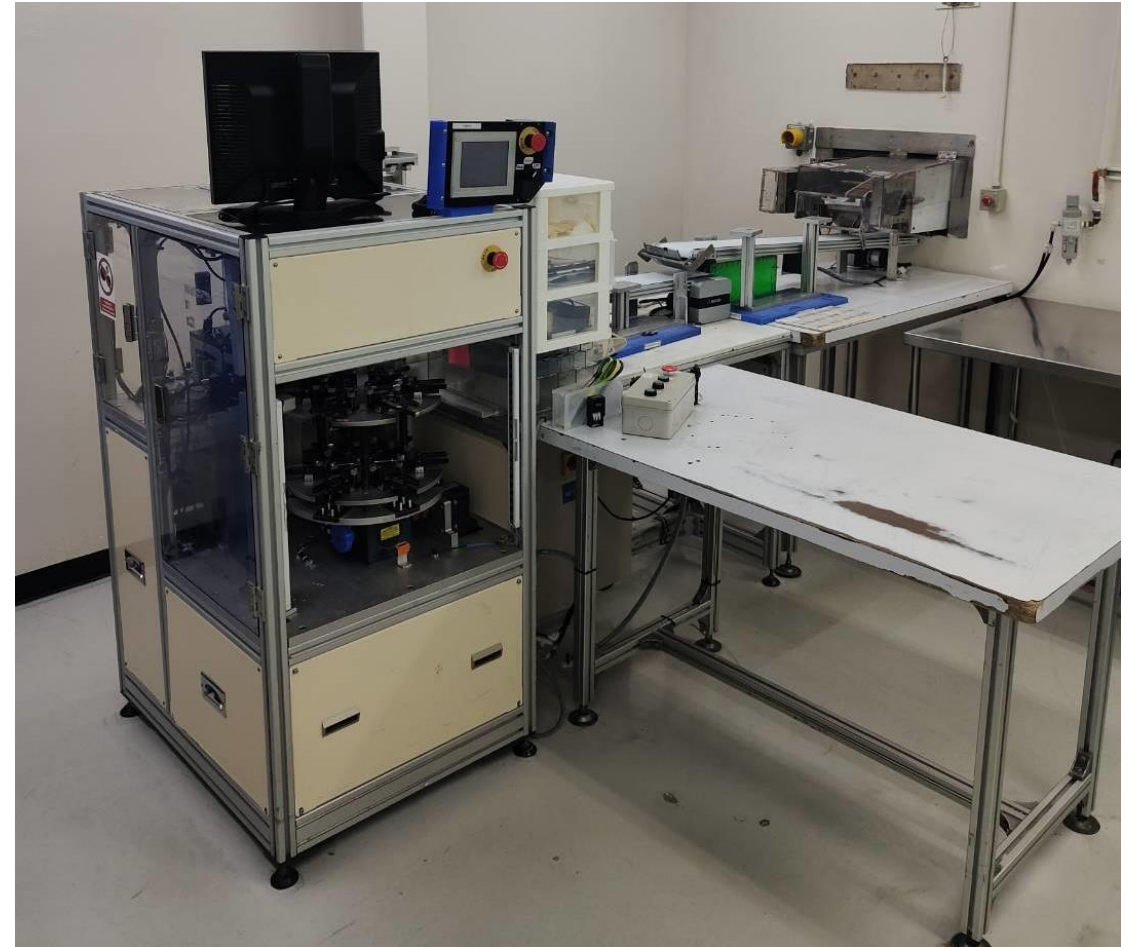

HEAT SPREADERS | ADVANCED LINES STAMPING 300 TON PRESS - TOTAL 3 UNITS



HEAT SPREADERS | ADVANCED LINES STAMPING 600T PRESS - TOTAL 2 UNITS



HEAT SPREADERS | ADVANCED LINES STAMPING 800T PRESS - 1 UNIT



HEAT SPREADERS | ADVANCED LINES STAMPING 1200T PRESS - TOTAL 1 UNIT



HEAT SPREADERS | ADVANCED LINES NI PLATING 4 LINES (SFF-LFF)



HEAT SPREADERS | ADVANCED LINES NI PLATING XLFF CAPABLE - NI PLATING LINE - 1 LINE

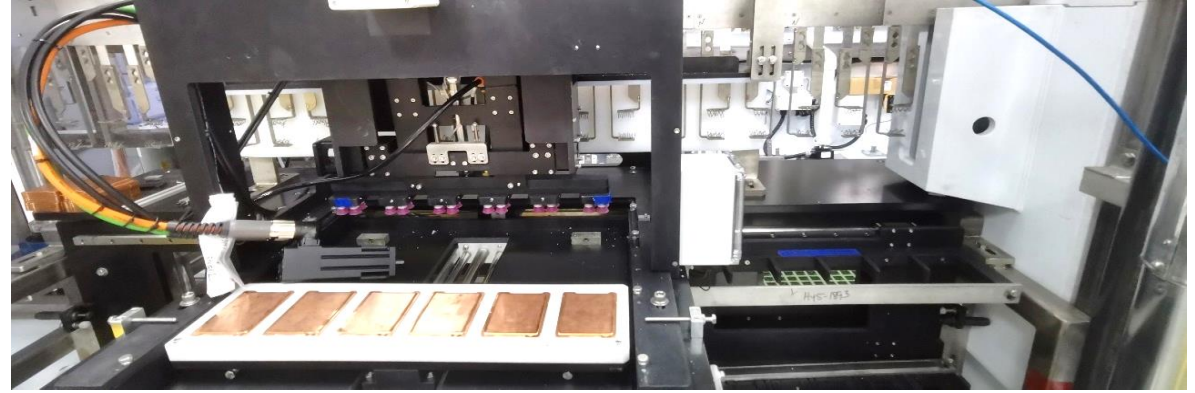

HEAT SPREADERS | ADVANCED LINES AU PLATING CONTINUOUS GOLD PLATING - 2 LINES



HEAT SPREADERS | ADVANCED LINES AU PLATING SEMI AUTO GOLD PLATING LINE



HEAT SPREADERS | ADVANCED LINES INSPECTION

